

2018 Swanton Bill Urban Memorial

Novice D1 36-40

Round 1

Tanner Mccullough Delta	Breccan Ford DWC	
Breccan Ford DWC	Fall 0:28	1

Jase Jensen NONE	Corbin Quick Swanton	
Corbin Quick Swanton	Dec 7-5	2

B. Ford (DWC)
1ST

Round 2

Brayden Nusbaum Lake Erie	Brayden Nusbaum Lake Erie	
Corbin Quick Swanton	Fall 0:54	50

Tanner Mccullough Delta	Jase Jensen NONE	
Jase Jensen NONE	TF 17-2	51

B. Nusbaum (Lake Erie)
2ND

Round 3

Brayden Nusbaum Lake Erie	Brayden Nusbaum Lake Erie	
Jase Jensen NONE	TF 16-1	99

Breccan Ford DWC	Breccan Ford DWC	
Corbin Quick Swanton	Dec 8-4	100

C. Quick (Swanton)
3RD

Round 4

Brayden Nusbaum Lake Erie	Breccan Ford DWC	
Breccan Ford DWC	Dec 8-6	129

Tanner Mccullough Delta	Corbin Quick Swanton	
Corbin Quick Swanton	TF 15-0	130

J. Jensen (NONE)
4TH

Round 5

Brayden Nusbaum Lake Erie	Brayden Nusbaum Lake Erie	
Tanner Mccullough Delta	Fall 1:47	179

Breccan Ford DWC	Breccan Ford DWC	
Jase Jensen NONE	TF 15-0	180

T. Mccullough (Delta)
5TH

2018 Swanton Bill Urban Memorial

Novice D1 40-42

Round 1

Reed Reiner SWC3	Brady Fulton Evergreen	3	Dec 9-4
Brady Fulton Evergreen			

Johnathon Jacobs NONE	Andrew Draeger PBG1	4	Fall 0:09
Andrew Draeger PBG1			

A. Draeger (PBG1)
1ST

Round 2

Tucker Hermes PPY2	Andrew Draeger PBG1	52	Fall 0:10
Andrew Draeger PBG1			

Reed Reiner SWC3	Reed Reiner SWC3	53	Fall 1:14
Johnathon Jacobs NONE			

T. Hermes (PPY2)
2ND

Round 3

Tucker Hermes PPY2	Tucker Hermes PPY2	101	Fall 0:21
Johnathon Jacobs NONE			

Brady Fulton Evergreen	Andrew Draeger PBG1	102	Fall 0:31
Andrew Draeger PBG1			

B. Fulton (Evergreen)
3RD

Round 4

Tucker Hermes PPY2	Tucker Hermes PPY2	131	Dec 8-7
Brady Fulton Evergreen			

Reed Reiner SWC3	Andrew Draeger PBG1	132	TF 15-0
Andrew Draeger PBG1			

R. Reiner (SWC3)
4TH

Round 5

Tucker Hermes PPY2	Reed Reiner SWC3	181	Dec 5-4
Reed Reiner SWC3			

Brady Fulton Evergreen	Brady Fulton Evergreen	182	Fall 0:47
Johnathon Jacobs NONE			

J. Jacobs (NONE)
5TH

2018 Swanton Bill Urban Memorial

Novice D1 43-44

Round 1

Levi Kline SYWRA		Levi Kline SYWRA
Braxton Sharples EWO3	5	Dec 13-8

Parker Kleeberg Beastmode		Parker Kleeberg Beastmode
Hunter Wolery PPY2	6	Fall 1:41

T. Carrizales (DWC)
1ST

Round 2

Troy Carrizales DWC		Troy Carrizales DWC
Hunter Wolery PPY2	54	Fall 0:45

Levi Kline SYWRA		Parker Kleeberg Beastmode
Parker Kleeberg Beastmode	55	TF 15-0

B. Sharples (EWO3)
2ND

Round 3

Troy Carrizales DWC		Troy Carrizales DWC
Parker Kleeberg Beastmode	103	TF 17-2

Braxton Sharples EWO3		Braxton Sharples EWO3
Hunter Wolery PPY2	104	Fall 1:00

P. Kleeberg (Beastmode)
3RD

Round 4

Troy Carrizales DWC		Troy Carrizales DWC
Braxton Sharples EWO3	133	Dec 10-4

Levi Kline SYWRA		Levi Kline SYWRA
Hunter Wolery PPY2	134	Fall 1:47

L. Kline (SYWRA)
4TH

Round 5

Troy Carrizales DWC		Troy Carrizales DWC
Levi Kline SYWRA	183	Dec 11-4

Braxton Sharples EWO3		Braxton Sharples EWO3
Parker Kleeberg Beastmode	184	Fall 2:29

H. Wolery (PPY2)
5TH

2018 Swanton Bill Urban Memorial

Novice D1 45-50

Round 1

Grady O'Brien PBG1	Spencer Evans PBG1
Spencer Evans PBG1	SV-1 6-4
7	

Logan Rajner SBD1	Logan Rajner SBD1
Sophianna Pedroza DEF2	TF 15-0
8	

L. Rajner (SBD1)
1ST

Round 2

Chase Smith Swanton	Chase Smith Swanton
Sophianna Pedroza DEF2	Dec 8-1
56	

Grady O'Brien PBG1	Logan Rajner SBD1
Logan Rajner SBD1	Dec 6-2
57	

S. Evans (PBG1)
2ND

Round 3

Chase Smith Swanton	Logan Rajner SBD1
Logan Rajner SBD1	Fall 1:53
105	

Spencer Evans PBG1	Spencer Evans PBG1
Sophianna Pedroza DEF2	Fall 1:17
106	

G. O'Brien (PBG1)
3RD

Round 4

Chase Smith Swanton	Spencer Evans PBG1
Spencer Evans PBG1	Fall 2:30
135	

Grady O'Brien PBG1	Grady O'Brien PBG1
Sophianna Pedroza DEF2	Dec 6-0
136	

C. Smith (Swanton)
4TH

Round 5

Chase Smith Swanton	Grady O'Brien PBG1
Grady O'Brien PBG1	Dec 8-1
185	

Spencer Evans PBG1	Logan Rajner SBD1
Logan Rajner SBD1	Dec 6-4
186	

S. Pedroza (DEF2)
5TH

2018 Swanton Bill Urban Memorial

Novice D1 51-56

Round 1

Braylen Hood TOM2	Lucas Earl DWC	
Lucas Earl DWC	Fall 1:00	9

Mason Gerken ARC3	Mason Gerken ARC3	
Zander Huff NONE	Fall 1:44	10

M. Gerken (ARC3)
1ST

Round 2

Hunter Smith DWC	Hunter Smith DWC	
Zander Huff NONE	Dec 6-0	58

Braylen Hood TOM2	Mason Gerken ARC3	
Mason Gerken ARC3	TF 16-1	59

L. Earl (DWC)
2ND

Round 3

Hunter Smith DWC	Mason Gerken ARC3	
Mason Gerken ARC3	Fall 0:31	107

Lucas Earl DWC	Lucas Earl DWC	
Zander Huff NONE	Fall 0:18	108

B. Hood (TOM2)
3RD

Round 4

Hunter Smith DWC	Lucas Earl DWC	
Lucas Earl DWC	Fall 1:50	137

Braylen Hood TOM2	Braylen Hood TOM2	
Zander Huff NONE	Dec 11-6	138

H. Smith (DWC)
4TH

Round 5

Hunter Smith DWC	Braylen Hood TOM2	
Braylen Hood TOM2	TF 26-11	187

Lucas Earl DWC	Mason Gerken ARC3	
Mason Gerken ARC3	Dec 11-4	188

Z. Huff (NONE)
5TH

2018 Swanton Bill Urban Memorial

Novice D1 59-59

Round 1

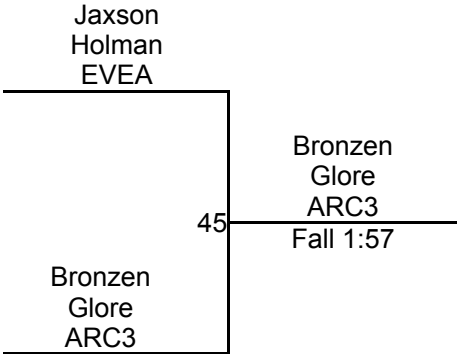

Round 2

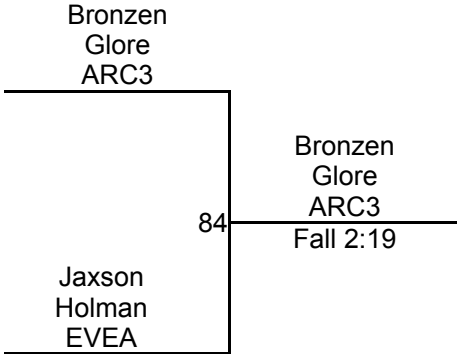

Round 3

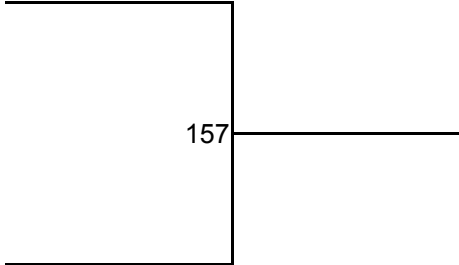

B. Glore (ARC3)
1ST

J. Holman (EVEA)
2ND

2018 Swanton Bill Urban Memorial

Novice D1 64-69

Round 1

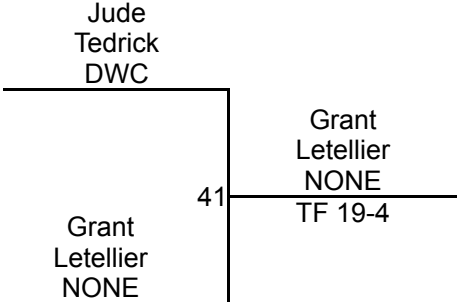

Round 2

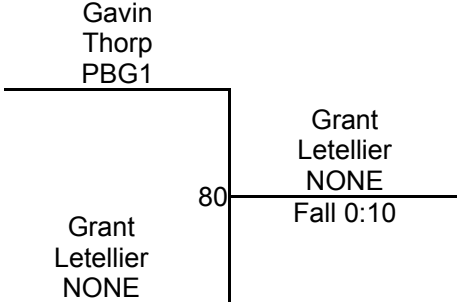

Round 3

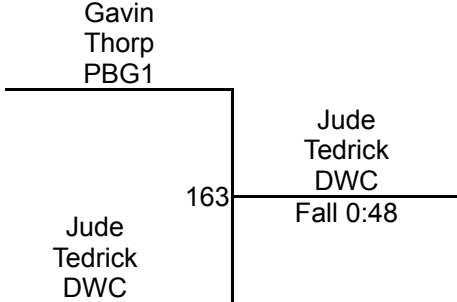

G. Letellier (NONE)
1ST

J. Tedrick (DWC)
2ND

G. Thorp (PBG1)
3RD

2018 Swanton Bill Urban Memorial

Novice D1 87-88

Round 1

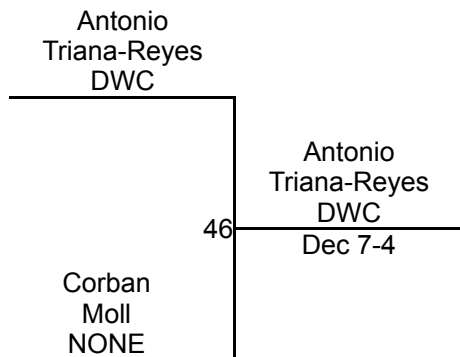

Round 2

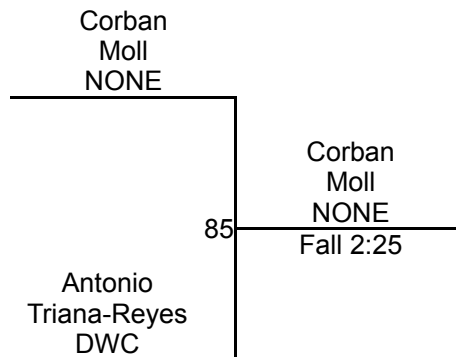

Round 3

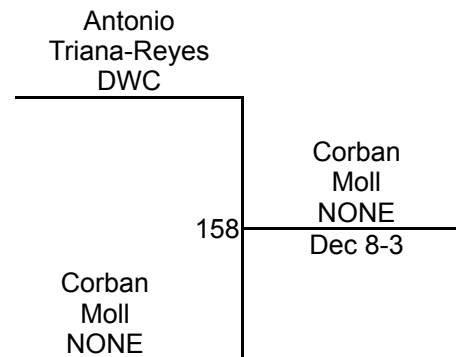

C. Moll (NONE)
1ST

A. Triana-Reyes (DWC)
2ND

2018 Swanton Bill Urban Memorial

Novice D2 40-44

Round 1

Zack Dominique GLWC		Zack Dominique GLWC
Carys Villaruz NONE	11	Dec 9-2

Camden Kimmel DWC3		George Pafford PBG1
George Pafford PBG1	12	Maj 10-2

D. Cook (SWC3)
1ST

Round 2

Dalton Cook SWC3		Dalton Cook SWC3
George Pafford PBG1	60	Fall 0:12

Zack Dominique GLWC		Camden Kimmel DWC3
Camden Kimmel DWC3	61	Maj 8-0

C. Kimmel (DWC3)
2ND

Round 3

Dalton Cook SWC3		Camden Kimmel DWC3
Camden Kimmel DWC3	109	Fall 2:55

Carys Villaruz NONE		George Pafford PBG1
George Pafford PBG1	110	Fall 0:59

G. Pafford (PBG1)
3RD

Round 4

Dalton Cook SWC3		Dalton Cook SWC3
Carys Villaruz NONE	139	TF 15-0

Zack Dominique GLWC		George Pafford PBG1
George Pafford PBG1	140	Dec 6-0

Z. Dominique (GLWC)
4TH

Round 5

Dalton Cook SWC3		Dalton Cook SWC3
Zack Dominique GLWC	189	Fall 0:39

Carys Villaruz NONE		Camden Kimmel DWC3
Camden Kimmel DWC3	190	Fall 0:30

C. Villaruz (NONE)
5TH

2018 Swanton Bill Urban Memorial

Novice D2 45-49

Round 1

Mason Pitzen DWC3	Mason Pitzen DWC3
Lindley Crow Kodiak	SV-1 6-4
13	

Jaydon Barner LCW3	Tanner Jensen NONE
Tanner Jensen NONE	TF 15-0
14	

T. Jensen (NONE)
1ST

Round 2

Collin Young EVEA	Tanner Jensen NONE
Tanner Jensen NONE	Fall 2:51
62	

Mason Pitzen DWC3	Mason Pitzen DWC3
Jaydon Barner LCW3	Fall 2:38
63	

M. Pitzen (DWC3)
2ND

Round 3

Collin Young EVEA	Collin Young EVEA
Jaydon Barner LCW3	Dec 7-3
111	

Lindley Crow Kodiak	Tanner Jensen NONE
Tanner Jensen NONE	Dec 7-6
112	

L. Crow (Kodiak)
3RD

Round 4

Collin Young EVEA	Lindley Crow Kodiak
Lindley Crow Kodiak	SV-1 10-8
141	

Mason Pitzen DWC3	Tanner Jensen NONE
Tanner Jensen NONE	Dec 4-2
142	

C. Young (EVEA)
4TH

Round 5

Collin Young EVEA	Mason Pitzen DWC3
Mason Pitzen DWC3	Fall 2:08
191	

Lindley Crow Kodiak	Lindley Crow Kodiak
Jaydon Barner LCW3	Fall 0:52
192	

J. Barner (LCW3)
5TH

2018 Swanton Bill Urban Memorial

Novice D2 48-52

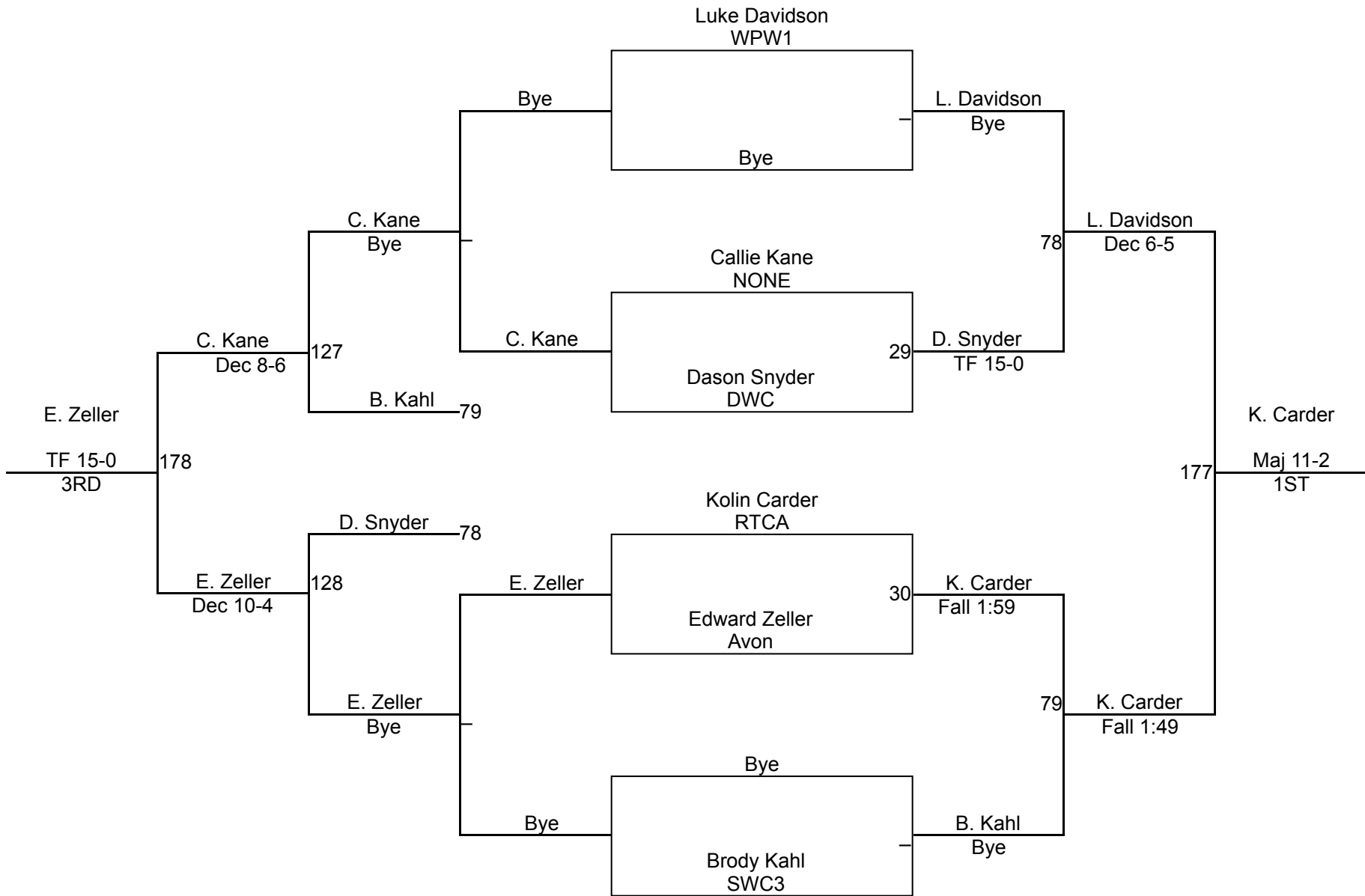

2018 Swanton Bill Urban Memorial

Novice D2 52-55

Round 1

Trinitilaine Bechstein NONE		Trinitilaine Bechstein NONE	
Colton Hadley NWWA	15	Fall 0:40	

David Clare GLWC		David Clare GLWC	
Grayson Smith PBG1	16	Fall 0:28	

D. Clare (GLWC)
1ST

Round 2

Clark Egan DWC		Clark Egan DWC	
Grayson Smith PBG1	64	TF 15-0	

Trinitilaine Bechstein NONE		David Clare GLWC	
David Clare GLWC	65	TF 16-1	

T. Bechstein (NONE)
2ND

Round 3

Clark Egan DWC		David Clare GLWC	
David Clare GLWC	113	Fall 0:15	

Colton Hadley NWWA		Colton Hadley NWWA	
Grayson Smith PBG1	114	TF 15-0	

C. Egan (DWC)
3RD

Round 4

Clark Egan DWC		Clark Egan DWC	
Colton Hadley NWWA	143	Dec 9-4	

Trinitilaine Bechstein NONE		Trinitilaine Bechstein NONE	
Grayson Smith PBG1	144	Fall 0:34	

C. Hadley (NWWA)
4TH

Round 5

Clark Egan DWC		Trinitilaine Bechstein NONE	
Trinitilaine Bechstein NONE	193	Fall 0:19	

Colton Hadley NWWA		David Clare GLWC	
David Clare GLWC	194	Fall 0:25	

G. Smith (PBG1)
5TH

2018 Swanton Bill Urban Memorial

Novice D2 55-57

Round 1

Joshua Croninger LCWC		Deegan Bowser SWC3
Deegan Bowser SWC3	31	Fall 0:21

Jarrett Zinz PBG1		Jarrett Zinz PBG1
Patrick O'Brien PBG1	32	Fall 2:31

Round 2

Joshua Croninger LCWC		Patrick O'Brien PBG1
Patrick O'Brien PBG1	89	Dec 4-0

Jarrett Zinz PBG1		Jarrett Zinz PBG1
Deegan Bowser SWC3	90	Dec 9-5

Round 3

Joshua Croninger LCWC		Jarrett Zinz PBG1
Jarrett Zinz PBG1	167	Fall 0:37

Patrick O'Brien PBG1		Deegan Bowser SWC3
Deegan Bowser SWC3	168	Fall 0:27

WRESTLERS

J. Croninger (LCWC)

D. Bowser (SWC3)

J. Zinz (PBG1)

P. O'Brien (PBG1)

J. Zinz (PBG1)

1ST

D. Bowser (SWC3)

2ND

P. O'Brien (PBG1)

3RD

J. Croninger (LCWC)

4TH

2018 Swanton Bill Urban Memorial

Novice D2 58-60

Round 1

Josiah Kimble PBG1	Josiah Kimble PBG1
Keegan D'Ambrosia ARC3	Fall 0:13
17	

Ace Ryan EVEA	Richie Barnes JPW
Richie Barnes JPW	TF 15-0
18	

R. Barnes (JPW)
1ST

Round 2

Logan Flores DWC	Richie Barnes JPW
Richie Barnes JPW	Fall 1:37
66	

Josiah Kimble PBG1	Josiah Kimble PBG1
Ace Ryan EVEA	Fall 1:20
67	

J. Kimble (PBG1)
2ND

Round 3

Logan Flores DWC	Ace Ryan EVEA
Ace Ryan EVEA	Dec 8-7
115	

Keegan D'Ambrosia ARC3	Richie Barnes JPW
Richie Barnes JPW	Fall 0:29
116	

A. Ryan (EVEA)
3RD

Round 4

Logan Flores DWC	Logan Flores DWC
Keegan D'Ambrosia ARC3	Fall 0:43
145	

Josiah Kimble PBG1	Richie Barnes JPW
Richie Barnes JPW	Fall 2:39
146	

L. Flores (DWC)
4TH

Round 5

Logan Flores DWC	Josiah Kimble PBG1
Josiah Kimble PBG1	TF 15-0
195	

Keegan D'Ambrosia ARC3	Ace Ryan EVEA
Ace Ryan EVEA	Fall 1:43
196	

K. D'Ambrosia (ARC3)
5TH

2018 Swanton Bill Urban Memorial

Novice D2 60-64

Round 1

Cayden Shippey Maumee		Kaed Merillat Archbold
Kaed Merillat Archbold	33	Fall 0:31

FORFEIT FORFEIT PBG1		Vincent Cisneros NONE
Vincent Cisneros NONE	34	FF

Round 2

Cayden Shippey Maumee		Vincent Cisneros NONE
Vincent Cisneros NONE	91	Fall 2:31

FORFEIT FORFEIT PBG1		Kaed Merillat Archbold
Kaed Merillat Archbold	92	FF

Round 3

Cayden Shippey Maumee		Cayden Shippey Maumee
FORFEIT FORFEIT PBG1	169	FF

Vincent Cisneros NONE		Vincent Cisneros NONE
Kaed Merillat Archbold	170	Fall 2:51

WRESTLERS

C. Shippey (Maumee)

K. Merillat (Archbold)

F. FORFEIT (PBG1)

V. Cisneros (NONE)

V. Cisneros (NONE)
1ST

K. Merillat (Archbold)
2ND

C. Shippey (Maumee)
3RD

F. FORFEIT (PBG1)
4TH

2018 Swanton Bill Urban Memorial

Novice D2 61-68

Round 1

Parker Wilson SWC3		Lucas Benson PBG1	
	35	TF 15-0	

Griffin Kline NONE		Griffin Kline NONE	
	36	Fall 0:42	

Round 2

Parker Wilson SWC3		Avree Kleeberg Beastmode	
	93	Dec 13-9	

Griffin Kline NONE		Griffin Kline NONE	
	94	Maj 16-8	

Round 3

Parker Wilson SWC3		Griffin Kline NONE	
	171	Fall 0:42	

Avree Kleeberg Beastmode		Lucas Benson PBG1	
	172	Fall 2:29	

WRESTLERS

P. Wilson (SWC3)

L. Benson (PBG1)

G. Kline (NONE)

A. Kleeberg (Beastmode)

G. Kline (NONE)

1ST

L. Benson (PBG1)

2ND

A. Kleeberg (Beastmode)

3RD

P. Wilson (SWC3)

4TH

2018 Swanton Bill Urban Memorial

Novice D2 69-73

Round 1

Ryan Moore PBG1		Ryan Moore PBG1
Clayton Eby DWC	37	Fall 1:44

Bailey Crow Kodiak		Bailey Crow Kodiak
Isaac Sifuentes SWC3	38	TF 16-1

Round 2

Ryan Moore PBG1		Ryan Moore PBG1
Isaac Sifuentes SWC3	95	Fall 1:48

Bailey Crow Kodiak		Bailey Crow Kodiak
Clayton Eby DWC	96	Fall 0:52

Round 3

Ryan Moore PBG1		Ryan Moore PBG1
Bailey Crow Kodiak	173	Fall 1:46

Isaac Sifuentes SWC3		Isaac Sifuentes SWC3
Clayton Eby DWC	174	Fall 1:58

WRESTLERS

- R. Moore (PBG1)
- C. Eby (DWC)
- B. Crow (Kodiak)
- I. Sifuentes (SWC3)

R. Moore (PBG1)
1ST

B. Crow (Kodiak)
2ND

I. Sifuentes (SWC3)
3RD

C. Eby (DWC)
4TH

2018 Swanton Bill Urban Memorial

Novice D2 71-80

Round 1

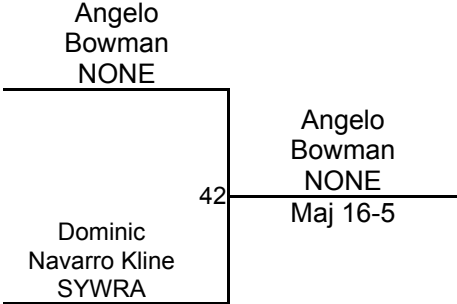

Round 2

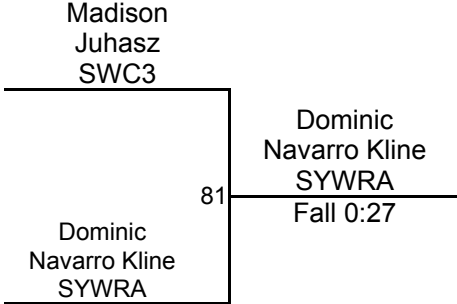

Round 3

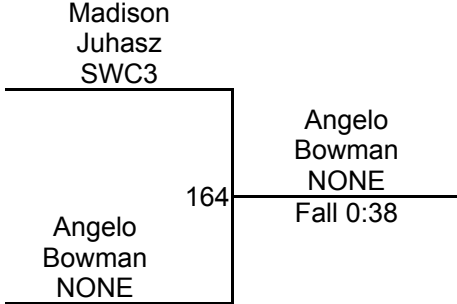

A. Bowman (NONE)
1ST

D. Navarro Kline (SYWRA)
2ND

M. Juhasz (SWC3)
3RD

2018 Swanton Bill Urban Memorial

Novice D2 99-109

Round 1

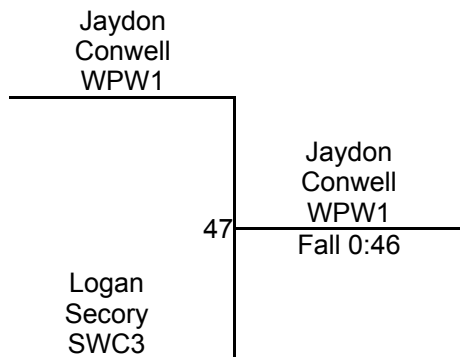

Round 2

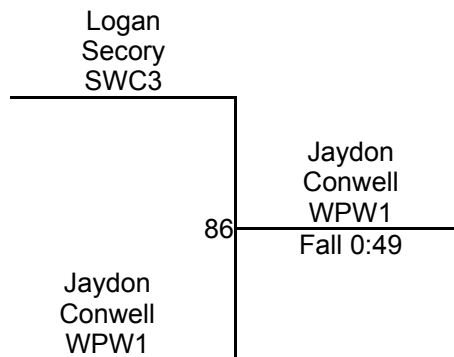

Round 3

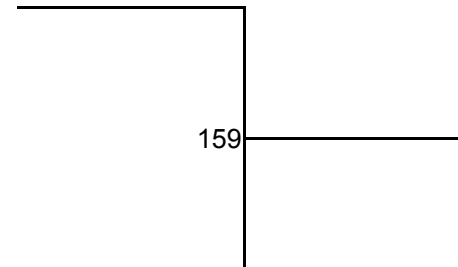

J. Conwell (WPW1)
1ST

L. Secory (SWC3)
2ND

2018 Swanton Bill Urban Memorial

Novice D3 53-60

Round 1

Chase Brodersen PBG1	Chase Brodersen PBG1
Jax Sterling PBG1	Fall 0:26
19	

Bryce Nusbaum Lake Erie	Jett Smith TOM2
Jett Smith TOM2	Fall 2:42
20	

K. Carder (RTCA)
1ST

Round 2

Kabin Carder RTCA	Kabin Carder RTCA
Jett Smith TOM2	Fall 2:15
68	

Chase Brodersen PBG1	Chase Brodersen PBG1
Bryce Nusbaum Lake Erie	Fall 2:32
69	

C. Brodersen (PBG1)
2ND

Round 3

Kabin Carder RTCA	Kabin Carder RTCA
Bryce Nusbaum Lake Erie	Fall 1:25
117	

Jax Sterling PBG1	Jax Sterling PBG1
Jett Smith TOM2	Dec 7-0
118	

J. Sterling (PBG1)
3RD

Round 4

Kabin Carder RTCA	Kabin Carder RTCA
Jax Sterling PBG1	Fall 1:32
147	

Chase Brodersen PBG1	Chase Brodersen PBG1
Jett Smith TOM2	Dec 6-4
148	

J. Smith (TOM2)
4TH

Round 5

Kabin Carder RTCA	Kabin Carder RTCA
Chase Brodersen PBG1	TF 15-0
197	

Jax Sterling PBG1	Jax Sterling PBG1
Bryce Nusbaum Lake Erie	TF 15-0
198	

B. Nusbaum (Lake Erie)
5TH

2018 Swanton Bill Urban Memorial

Novice D3 63-70

Round 1

Michael Stobinski Lake Erie		Michael Stobinski Lake Erie
Brayden Gearig SWC3	39	Fall 1:32

Bryce Hudson NAP2		Mackenzie Carder RTCA
Mackenzie Carder RTCA	40	TF 15-0

Round 2

Michael Stobinski Lake Erie		Mackenzie Carder RTCA
Mackenzie Carder RTCA	97	TF 15-0

Bryce Hudson NAP2		Brayden Gearig SWC3
Brayden Gearig SWC3	98	Fall 1:26

Round 3

Michael Stobinski Lake Erie		Michael Stobinski Lake Erie
Bryce Hudson NAP2	175	Fall 0:15

Mackenzie Carder RTCA		Mackenzie Carder RTCA
Brayden Gearig SWC3	176	Fall 1:27

WRESTLERS

M. Stobinski (Lake Erie)

B. Gearig (SWC3)

B. Hudson (NAP2)

M. Carder (RTCA)

M. Carder (RTCA)

1ST

M. Stobinski (Lake Erie)

2ND

B. Gearig (SWC3)

3RD

B. Hudson (NAP2)

4TH

2018 Swanton Bill Urban Memorial

Novice D3 73-83

Round 1

Adalyn Newberry NONE	Jordan Odle AW	
Jordan Odle AW	21	Dec 10-7

Ethan Bowman Archbold	Ethan Bowman Archbold	
Wade Stubleski EVEA	22	Fall 2:25

E. Bowman (Archbold)
1ST

Round 2

Zack Davidson WPW1	Wade Stubleski EVEA	
Wade Stubleski EVEA	70	Dec 6-2

Adalyn Newberry NONE	Ethan Bowman Archbold	
Ethan Bowman Archbold	71	TF 15-0

J. Odle (AW)
2ND

Round 3

Zack Davidson WPW1	Ethan Bowman Archbold	
Ethan Bowman Archbold	119	Dec 8-1

Jordan Odle AW	Jordan Odle AW	
Wade Stubleski EVEA	120	Fall 1:27

W. Stubleski (EVEA)
3RD

Round 4

Zack Davidson WPW1	Jordan Odle AW	
Jordan Odle AW	149	Fall 0:51

Adalyn Newberry NONE	Wade Stubleski EVEA	
Wade Stubleski EVEA	150	Dec 7-6

Z. Davidson (WPW1)
4TH

Round 5

Zack Davidson WPW1	Zack Davidson WPW1	
Adalyn Newberry NONE	199	Fall 1:48

Jordan Odle AW	Ethan Bowman Archbold	
Ethan Bowman Archbold	200	Dec 4-2

A. Newberry (NONE)
5TH

2018 Swanton Bill Urban Memorial

Novice D3 79-85

Round 1

Connor Hockenbery RTCA		Brendon Rowe OEW1	
Brendon Rowe OEW1	23	Maj 16-5	

Brayden Gonzales SWC3		Brayden Gonzales SWC3	
Caylynn Carpenter PBG1	24	Fall 1:20	

B. Rowe (OEW1)
1ST

Round 2

Billy Krueger NONE		Billy Krueger NONE	
Caylynn Carpenter PBG1	72	Fall 1:44	

Connor Hockenbery RTCA		Connor Hockenbery RTCA	
Brayden Gonzales SWC3	73	Fall 0:52	

C. Hockenbery (RTCA)
2ND

Round 3

Billy Krueger NONE		Brayden Gonzales SWC3	
Brayden Gonzales SWC3	121	Dec 8-4	

Brendon Rowe OEW1		Brendon Rowe OEW1	
Caylynn Carpenter PBG1	122	Fall 0:31	

B. Gonzales (SWC3)
3RD

Round 4

Billy Krueger NONE		Brendon Rowe OEW1	
Brendon Rowe OEW1	151	TF 15-0	

Connor Hockenbery RTCA		Connor Hockenbery RTCA	
Caylynn Carpenter PBG1	152	Fall 2:24	

B. Krueger (NONE)
4TH

Round 5

Billy Krueger NONE		Connor Hockenbery RTCA	
Connor Hockenbery RTCA	201	Fall 1:52	

Brendon Rowe OEW1		Brendon Rowe OEW1	
Brayden Gonzales SWC3	202	Fall 0:22	

C. Carpenter (PBG1)
5TH

2018 Swanton Bill Urban Memorial

Novice D3 86-93

Round 1

Garrett Dziengelewski SWC3	Brendan Upham SWC3	25	TF 15-0
Brendan Upham SWC3			

Tucker Knappins PPY2	Tucker Knappins PPY2	26	Dec 8-3
FORFEIT Came FORFEIT Ashley PBG1			

Z. Timler (JPWA)
1ST

Round 2

Zane Timler JPWA	Zane Timler JPWA	74	Fall 2:50
FORFEIT Came FORFEIT Ashley PBG1			

Garrett Dziengelewski SWC3	Tucker Knappins PPY2	75	Fall 1:51
Tucker Knappins PPY2			

B. Upham (SWC3)
2ND

Round 3

Zane Timler JPWA	Zane Timler JPWA	123	TF 16-1
Tucker Knappins PPY2			

Brendan Upham SWC3	Brendan Upham SWC3	124	FF
FORFEIT Came FORFEIT Ashley PBG1			

T. Knappins (PPY2)
3RD

Round 4

Zane Timler JPWA	Zane Timler JPWA	153	Fall 2:51
Brendan Upham SWC3			

Garrett Dziengelewski SWC3	Garrett Dziengelewski SWC3	154	FF
FORFEIT Came FORFEIT Ashley PBG1			

G. Dziengelewski (SWC3)
4TH

Round 5

Zane Timler JPWA	Zane Timler JPWA	203	TF 15-0
Garrett Dziengelewski SWC3			

Brendan Upham SWC3	Brendan Upham SWC3	204	Fall 0:53
Tucker Knappins PPY2			

F. FORFEIT Ashley (PBG1)
5TH

2018 Swanton Bill Urban Memorial

Novice D3 99-106

Round 1

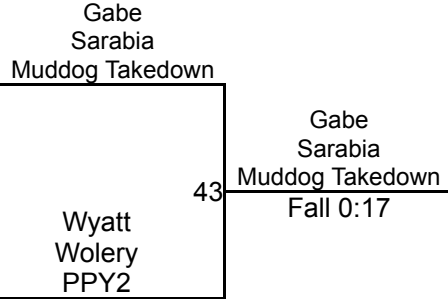

Round 2

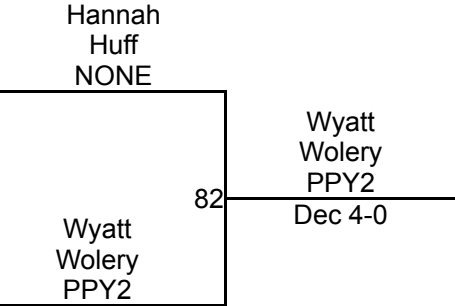

Round 3

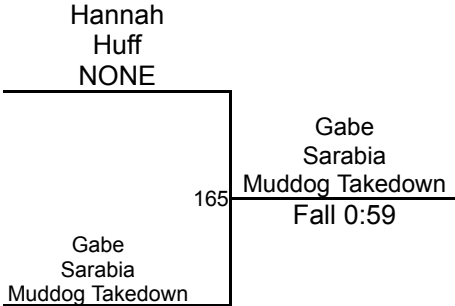

G. Sarabia (Muddog Takedown)
1ST

W. Wolery (PPY2)
2ND

H. Huff (NONE)
3RD

2018 Swanton Bill Urban Memorial

Novice D3 122-126

Round 1

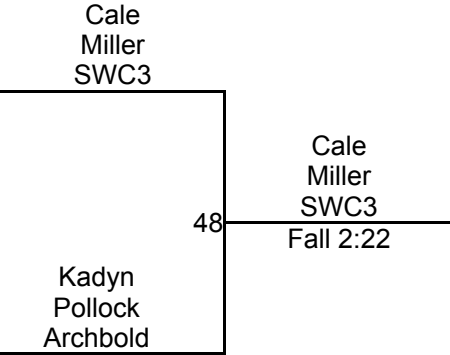

Round 2

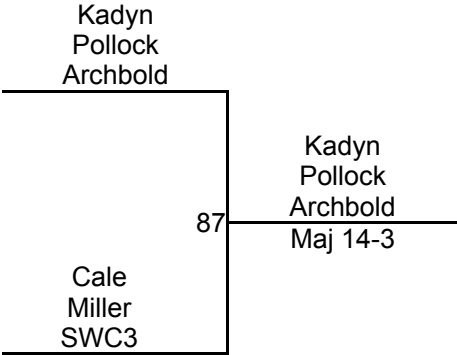

Round 3

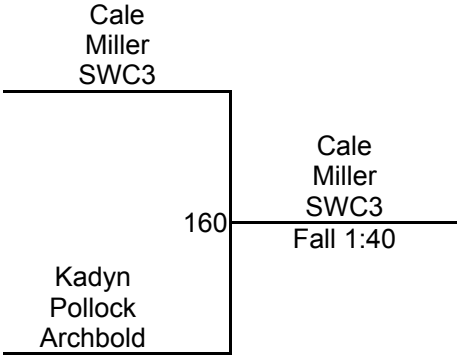

C. Miller (SWC3)
1ST

K. Pollock (Archbold)
2ND

2018 Swanton Bill Urban Memorial

Novice D4 74-81

Round 1

Josh Pfeiffer NONE	Josh Pfeiffer NONE Maj 9-0
Landon Massie LCWC	27

Robert Arellano JPWA	Parker Cone DWC3 Fall 1:35
Parker Cone DWC3	28

J. Pfeiffer (NONE)
1ST

Round 2

Joseph Mosko DWC	Parker Cone DWC3 Fall 0:32
Parker Cone DWC3	76

Josh Pfeiffer NONE	Josh Pfeiffer NONE Fall 1:44
Robert Arellano JPWA	77

P. Cone (DWC3)
2ND

Round 3

Joseph Mosko DWC	Robert Arellano JPWA Fall 2:55
Robert Arellano JPWA	125

Landon Massie LCWC	Parker Cone DWC3 Fall 2:00
Parker Cone DWC3	126

L. Massie (LCWC)
3RD

Round 4

Joseph Mosko DWC	Landon Massie LCWC Fall 2:58
Landon Massie LCWC	155

Josh Pfeiffer NONE	Josh Pfeiffer NONE Fall 2:49
Parker Cone DWC3	156

R. Arellano (JPWA)
4TH

Round 5

Joseph Mosko DWC	Josh Pfeiffer NONE Fall 1:27
Josh Pfeiffer NONE	205

Landon Massie LCWC	Landon Massie LCWC Dec 9-3
Robert Arellano JPWA	206

J. Mosko (DWC)
5TH

2018 Swanton Bill Urban Memorial

Novice D4 86-94

Round 1

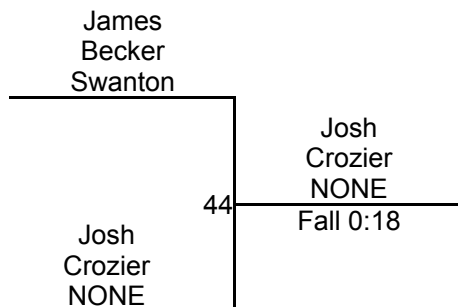

Round 2

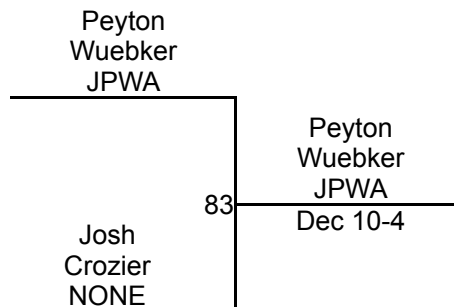

Round 3

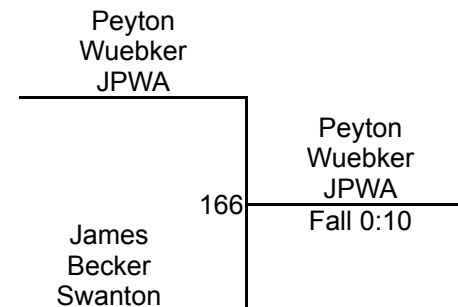

P. Wuebker (JPWA)

1ST

J. Crozier (NONE)

2ND

J. Becker (Swanton)

3RD

2018 Swanton Bill Urban Memorial

Novice D4 96-98

Round 1

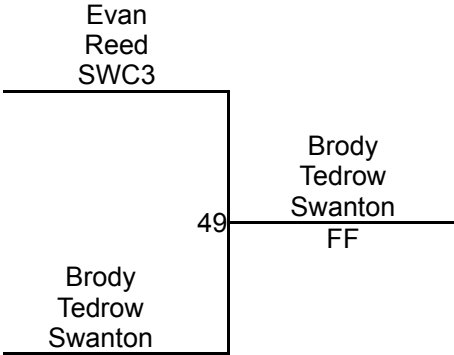

Round 2

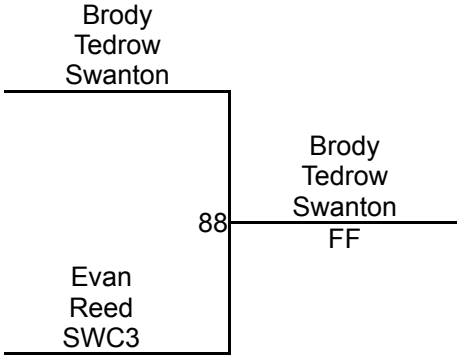

Round 3

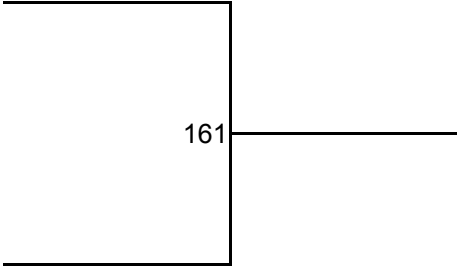

B. Tedrow (Swanton)
1ST

E. Reed (SWC3)
2ND

2018 Swanton Bill Urban Memorial

Division I 39-43

Round 1

Mateo Mata GENA		Mateo Mata GENA
Jake Leitner Compound	36	Dec 6-2

Dawson Wicker PAW3		Parker Kleeberg Beastmode
Parker Kleeberg Beastmode	37	Fall 0:34

Round 2

Mateo Mata GENA		Parker Kleeberg Beastmode
Parker Kleeberg Beastmode	105	TF 15-0

Dawson Wicker PAW3		Dawson Wicker PAW3
Jake Leitner Compound	106	Fall 1:30

Round 3

Mateo Mata GENA		Mateo Mata GENA
Dawson Wicker PAW3	192	Fall 2:54

Parker Kleeberg Beastmode		Parker Kleeberg Beastmode
Jake Leitner Compound	193	Dec 4-2

WRESTLERS

M. Mata (GENA)

J. Leitner (Compound)

D. Wicker (PAW3)

P. Kleeberg (Beastmode)

P. Kleeberg (Beastmode)
—————
1ST

M. Mata (GENA)
—————
2ND

D. Wicker (PAW3)
—————
3RD

J. Leitner (Compound)
—————
4TH

2018 Swanton Bill Urban Memorial

Division I 45-48

Round 1

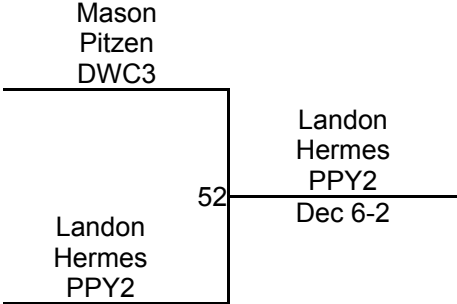

Round 2

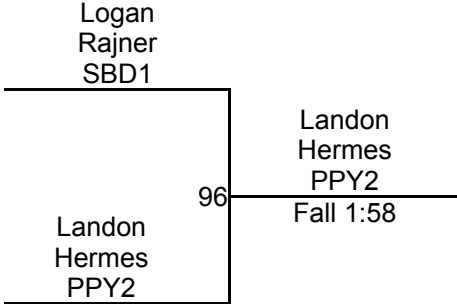

Round 3

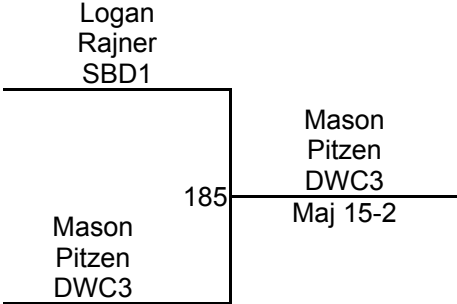

L. Hermes (PPY2)
1ST

M. Pitzen (DWC3)
2ND

L. Rajner (SBD1)
3RD

2018 Swanton Bill Urban Memorial

Division I 48-50

Round 1

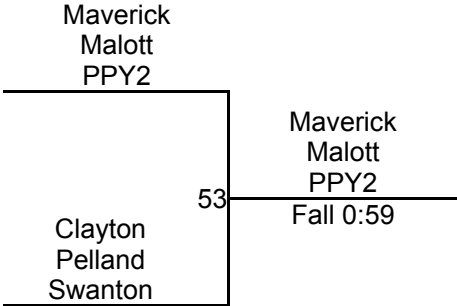

Round 2

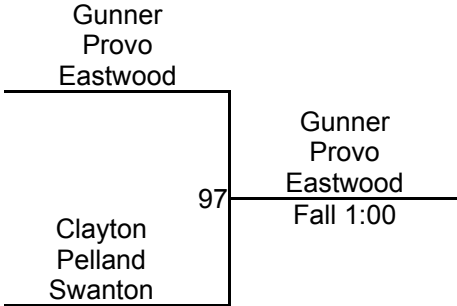

Round 3

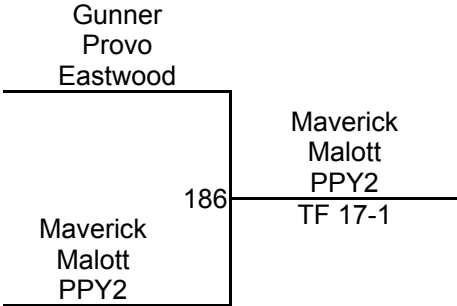

M. Malott (PPY2)
1ST

G. Provo (Eastwood)
2ND

C. Pelland (Swanton)
3RD

2018 Swanton Bill Urban Memorial

Division I 58-64

Round 1

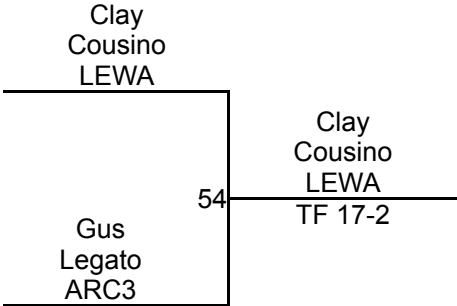

Round 2

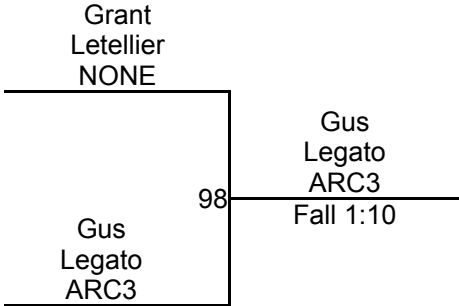

Round 3

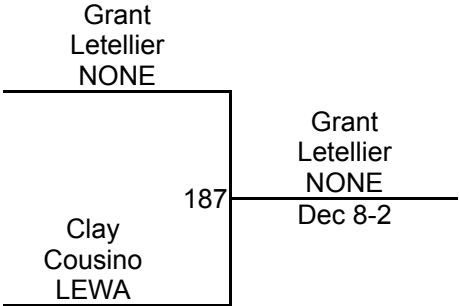

G. Legato (ARC3)
1ST

C. Cousino (LEWA)
2ND

G. Letellier (NONE)
3RD

2018 Swanton Bill Urban Memorial

Division II 40-43

Round 1

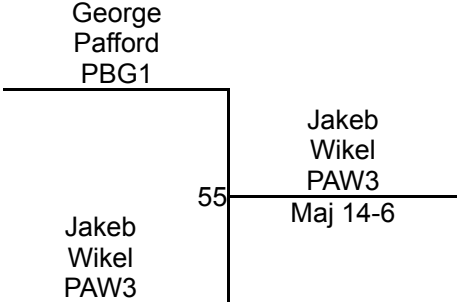

Round 2

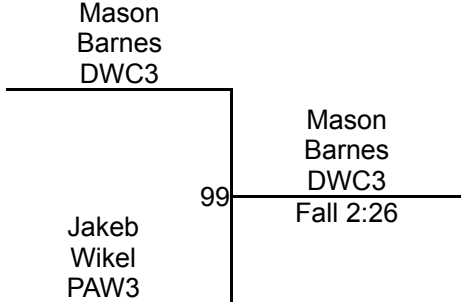

Round 3

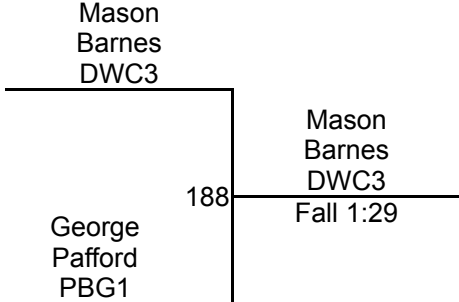

M. Barnes (DWC3)
1ST

J. Wikel (PAW3)
2ND

G. Pafford (PBG1)
3RD

2018 Swanton Bill Urban Memorial

Division II 48-52

Round 1

Lindley Crow Kodiak	Evan Black PBG1	
Evan Black PBG1	1	TF 16-1

Edward Zeller Avn1	Marcos Mata GENA	
Marcos Mata GENA	2	Dec 9-7

M. Mata (GENA)
1ST

Round 2

Trinitilaine Bechstein NONE	Marcos Mata GENA	
Marcos Mata GENA	61	Maj 11-1

Lindley Crow Kodiak	Edward Zeller Avn1	
Edward Zeller Avn1	62	Dec 7-1

E. Black (PBG1)
2ND

Round 3

Trinitilaine Bechstein NONE	Trinitilaine Bechstein NONE	
Edward Zeller Avn1	121	Fall 1:18

Evan Black PBG1	Marcos Mata GENA	
Marcos Mata GENA	122	Fall 0:32

T. Bechstein (NONE)
3RD

Round 4

Trinitilaine Bechstein NONE	Evan Black PBG1	
Evan Black PBG1	155	Dec 8-4

Lindley Crow Kodiak	Marcos Mata GENA	
Marcos Mata GENA	156	Fall 0:40

E. Zeller (Avn1)
4TH

Round 5

Trinitilaine Bechstein NONE	Trinitilaine Bechstein NONE	
Lindley Crow Kodiak	214	Fall 2:36

Evan Black PBG1	Evan Black PBG1	
Edward Zeller Avn1	215	Fall 2:19

L. Crow (Kodiak)
5TH

2018 Swanton Bill Urban Memorial

Division II 51-53

Round 1

Carter Kantner DEJ3	Isaac Brown NONE	3	TF 17-2
Isaac Brown NONE			

Venancio Pedroza DEF2	Venancio Pedroza DEF2	4	Maj 9-0
Collinn Ollom HWSA			

H. Meeker (PBG1)
1ST

Round 2

Hunter Meeker PBG1	Hunter Meeker PBG1	63	TF 16-1
Collinn Ollom HWSA			

Carter Kantner DEJ3	Venancio Pedroza DEF2	64	Fall 1:09
Venancio Pedroza DEF2			

I. Brown (NONE)
2ND

Round 3

Hunter Meeker PBG1	Hunter Meeker PBG1	123	TF 15-0
Venancio Pedroza DEF2			

Isaac Brown NONE	Isaac Brown NONE	124	TF 15-0
Collinn Ollom HWSA			

V. Pedroza (DEF2)
3RD

Round 4

Hunter Meeker PBG1	Hunter Meeker PBG1	157	TF 15-0
Isaac Brown NONE			

Carter Kantner DEJ3	Collinn Ollom HWSA	158	Maj 10-0
Collinn Ollom HWSA			

C. Ollom (HWSA)
4TH

Round 5

Hunter Meeker PBG1	Hunter Meeker PBG1	216	Fall 0:26
Carter Kantner DEJ3			

Isaac Brown NONE	Isaac Brown NONE	217	Maj 16-6
Venancio Pedroza DEF2			

C. Kantner (DEJ3)
5TH

2018 Swanton Bill Urban Memorial

Division II 52-57

Round 1

FORFEIT FORFEIT PBG1	Wyatt Pollock HSWA	5	Dec 7-3
Wyatt Pollock HSWA			

Stone Meggitt HSWA	Stone Meggitt HSWA	6	Maj 11-3
Maximus Kleeberg NONE			

W. Pollock (HSWA)
1ST

Round 2

David Clare GLWC	Maximus Kleeberg NONE	65	Maj 10-0
Maximus Kleeberg NONE			

FORFEIT FORFEIT PBG1	Stone Meggitt HSWA	66	FF
Stone Meggitt HSWA			

S. Meggitt (HSWA)
2ND

Round 3

David Clare GLWC	Stone Meggitt HSWA	125	Maj 9-0
Stone Meggitt HSWA			

Wyatt Pollock HSWA	Wyatt Pollock HSWA	126	Dec 7-5
Maximus Kleeberg NONE			

M. Kleeberg (NONE)
3RD

Round 4

David Clare GLWC	Wyatt Pollock HSWA	159	Dec 7-1
Wyatt Pollock HSWA			

FORFEIT FORFEIT PBG1	Maximus Kleeberg NONE	160	FF
Maximus Kleeberg NONE			

D. Clare (GLWC)
4TH

Round 5

David Clare GLWC	David Clare GLWC	218	FF
FORFEIT PBG1			

Wyatt Pollock HSWA	Wyatt Pollock HSWA	219	Dec 2-0
Stone Meggitt HSWA			

F. FORFEIT (PBG1)
5TH

2018 Swanton Bill Urban Memorial

Division II 56-61

Round 1

Grayson Vaillant NONE	Connor Medjesky PBG1
Connor Medjesky PBG1	Fall 0:19

Trey Kromer PPY2	Collin Norwalk GENA
Collin Norwalk GENA	Dec 8-2

C. Medjesky (PBG1)
1ST

Round 2

Noah Gutierrez HSWA	Collin Norwalk GENA
Collin Norwalk GENA	Dec 4-0

Grayson Vaillant NONE	Trey Kromer PPY2
Trey Kromer PPY2	Fall 2:53

C. Norwalk (GENA)
2ND

Round 3

Noah Gutierrez HSWA	Trey Kromer PPY2
Trey Kromer PPY2	Dec 13-8

Connor Medjesky PBG1	Connor Medjesky PBG1
Collin Norwalk GENA	TF 15-0

T. Kromer (PPY2)
3RD

Round 4

Noah Gutierrez HSWA	Connor Medjesky PBG1
Connor Medjesky PBG1	Fall 1:28

Grayson Vaillant NONE	Grayson Vaillant NONE
Collin Norwalk GENA	Dec 5-2

N. Gutierrez (HSWA)
4TH

Round 5

Noah Gutierrez HSWA	Noah Gutierrez HSWA
Grayson Vaillant NONE	Dec 9-7

Connor Medjesky PBG1	Connor Medjesky PBG1
Trey Kromer PPY2	Fall 1:23

G. Vaillant (NONE)
5TH

2018 Swanton Bill Urban Memorial

Division II 62-68

Round 1

Aj Gleckler EVEA	Aj Gleckler EVEA
Landon Hendricks SWC3	TF 15-0
9	

Griffin Kline NONE	Trenton McBride Eastwood
Trenton McBride Eastwood	Fall 1:50
10	

H. Carpenter (PBG1)
1ST

Round 2

Hughie Carpenter PBG1	Hughie Carpenter PBG1
Trenton McBride Eastwood	TF 15-0
69	

Aj Gleckler EVEA	Aj Gleckler EVEA
Griffin Kline NONE	Dec 10-3
70	

A. Gleckler (EVEA)
2ND

Round 3

Hughie Carpenter PBG1	Hughie Carpenter PBG1
Griffin Kline NONE	Fall 0:56
129	

Landon Hendricks SWC3	Landon Hendricks SWC3
Trenton McBride Eastwood	Maj 18-7
130	

L. Hendricks (SWC3)
3RD

Round 4

Hughie Carpenter PBG1	Hughie Carpenter PBG1
Landon Hendricks SWC3	Fall 0:43
163	

Aj Gleckler EVEA	Aj Gleckler EVEA
Trenton McBride Eastwood	TF 15-0
164	

T. McBride (Eastwood)
4TH

Round 5

Hughie Carpenter PBG1	Hughie Carpenter PBG1
Aj Gleckler EVEA	Maj 11-2
222	

Landon Hendricks SWC3	Landon Hendricks SWC3
Griffin Kline NONE	Fall 1:41
223	

G. Kline (NONE)
5TH

2018 Swanton Bill Urban Memorial

Division II 69-75

Round 1

Nas Taalib-Dean GLWC		Zeke DuShane PBG1	
Zeke DuShane PBG1	11	Fall 2:44	

Emery Reese HWSA		Brody Jaqua LCW3	
Brody Jaqua LCW3	12	Fall 2:24	

Z. DuShane (PBG1)
1ST

Round 2

Ryan Moore PBG1		Ryan Moore PBG1	
Brody Jaqua LCW3	71	Fall 2:00	

Nas Taalib-Dean GLWC		Nas Taalib-Dean GLWC	
Emery Reese HWSA	72	Dec 8-4	

R. Moore (PBG1)
2ND

Round 3

Ryan Moore PBG1		Ryan Moore PBG1	
Emery Reese HWSA	131	TF 15-0	

Zeke DuShane PBG1		Zeke DuShane PBG1	
Brody Jaqua LCW3	132	Fall 0:24	

N. Taalib-Dean (GLWC)
3RD

Round 4

Ryan Moore PBG1		Zeke DuShane PBG1	
Zeke DuShane PBG1	165	Maj 10-0	

Nas Taalib-Dean GLWC		Nas Taalib-Dean GLWC	
Brody Jaqua LCW3	166	Fall 2:52	

B. Jaqua (LCW3)
4TH

Round 5

Ryan Moore PBG1		Ryan Moore PBG1	
Nas Taalib-Dean GLWC	224	Fall 2:46	

Zeke DuShane PBG1		Zeke DuShane PBG1	
Emery Reese HWSA	225	Fall 0:26	

E. Reese (HWSA)
5TH

2018 Swanton Bill Urban Memorial

Division II 82-90

Round 1

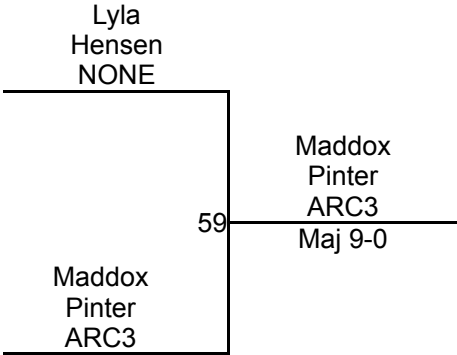

Round 2

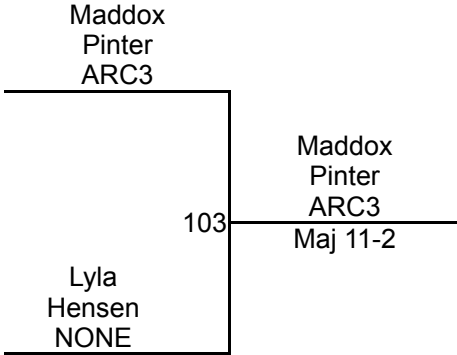

Round 3

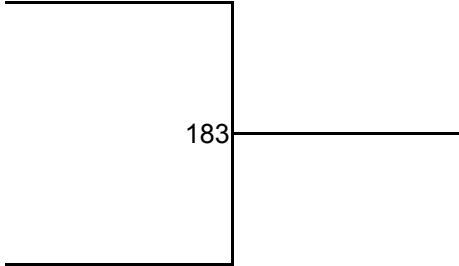

M. Pinter (ARC3)
1ST

L. Hensen (NONE)
2ND

2018 Swanton Bill Urban Memorial

Division II 99-102

Round 1

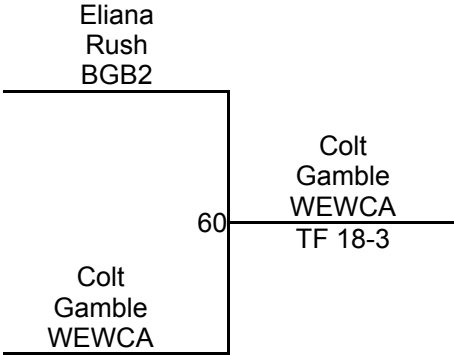

Round 2

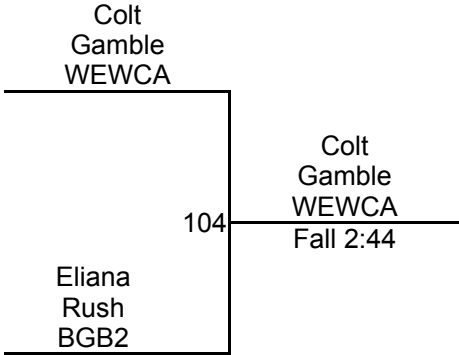

Round 3

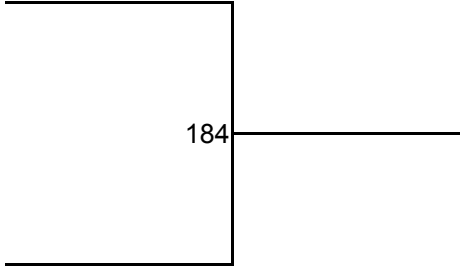

C. Gamble (WEWCA)
1ST

E. Rush (BGB2)
2ND

2018 Swanton Bill Urban Memorial

Division III 52-58

Round 1

Collin Bagdonas PBG1		Collin Bagdonas PBG1
Billy Dominique GLWC	38	Fall 0:44

Connor Bagdonas PBG1		Connor Bagdonas PBG1
Thomas Hernandez DWC3	39	Fall 2:57

Round 2

Collin Bagdonas PBG1		Collin Bagdonas PBG1
Thomas Hernandez DWC3	107	Fall 0:56

Connor Bagdonas PBG1		Connor Bagdonas PBG1
Billy Dominique GLWC	108	Fall 0:37

Round 3

Collin Bagdonas PBG1		Collin Bagdonas PBG1
Connor Bagdonas PBG1	194	Dec 4-0

Thomas Hernandez DWC3		Thomas Hernandez DWC3
Billy Dominique GLWC	195	Fall 2:56

WRESTLERS

C. Bagdonas (PBG1)

B. Dominique (GLWC)

C. Bagdonas (PBG1)

T. Hernandez (DWC3)

C. Bagdonas (PBG1)
1ST

C. Bagdonas (PBG1)
2ND

T. Hernandez (DWC3)
3RD

B. Dominique (GLWC)
4TH

2018 Swanton Bill Urban Memorial

Division III 58-65

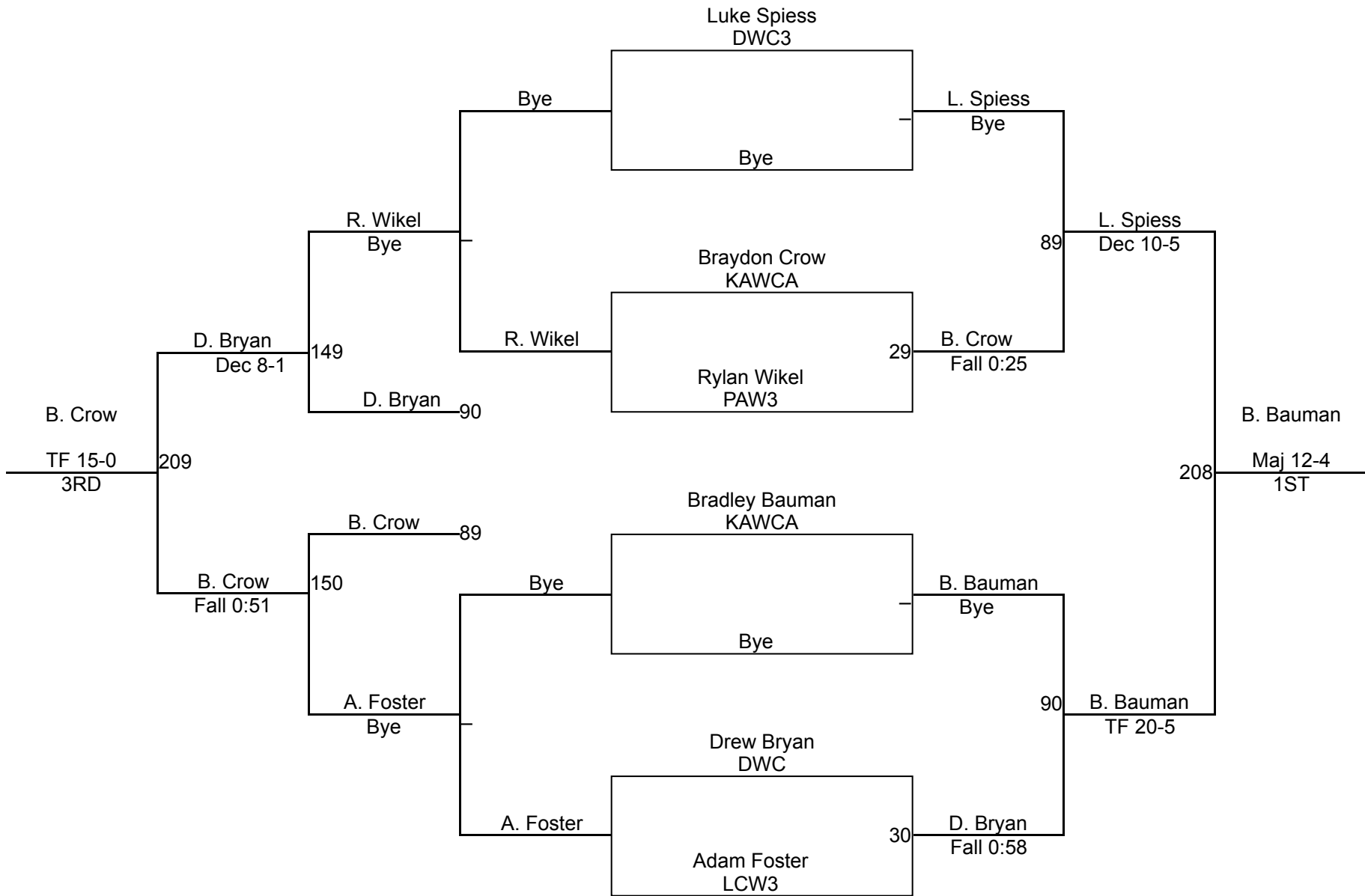

2018 Swanton Bill Urban Memorial

Division III 66-69

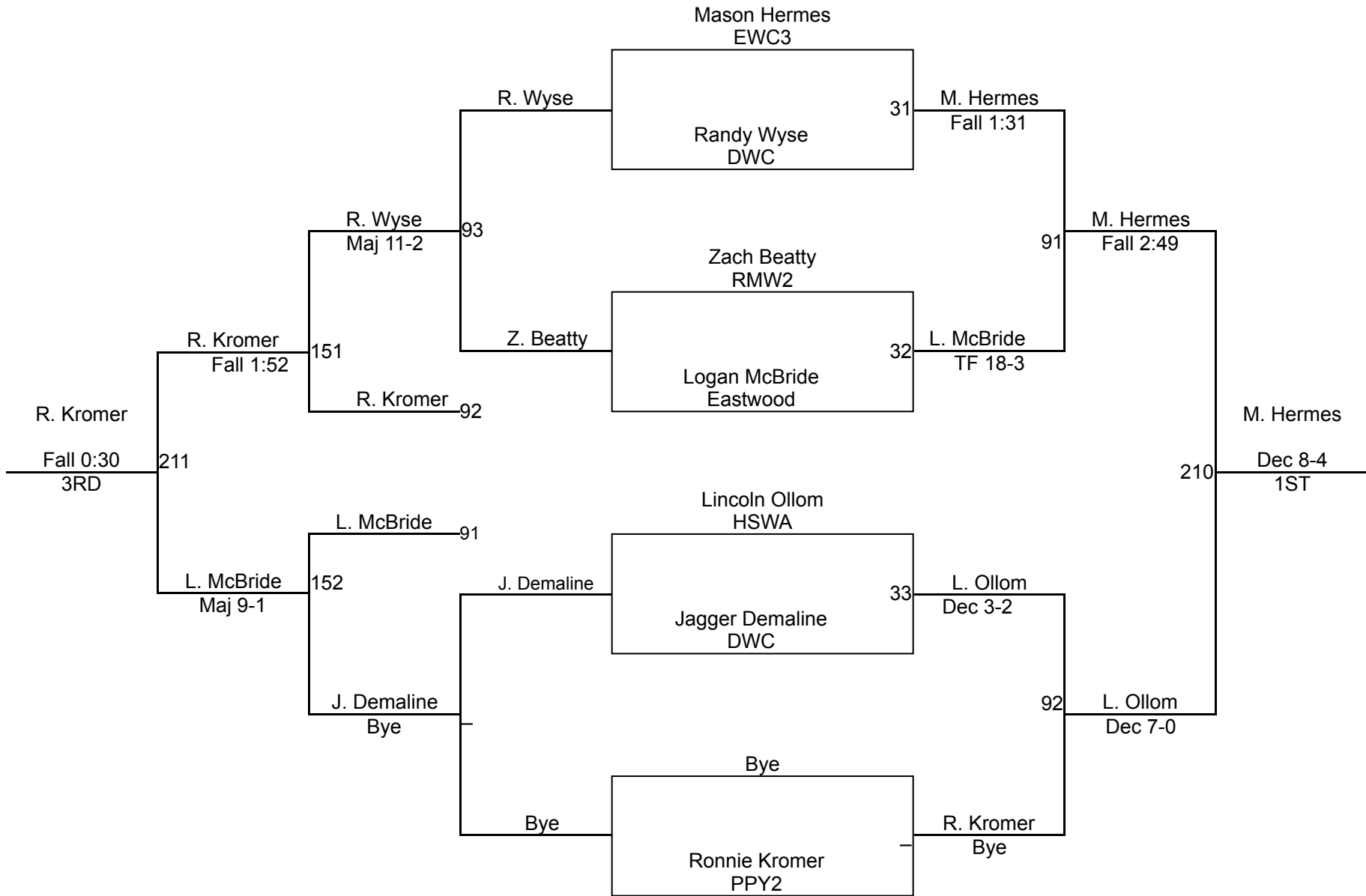

2018 Swanton Bill Urban Memorial

Division III 67-69

Round 1

Drew LaPoint SWC3		Drew LaPoint SWC3
Eli Guerra LEB1	13	Fall 1:40

Nathan Thebeau Swanton		Michael Stobinski Lake Erie
Michael Stobinski Lake Erie	14	Maj 10-2

H. Pollock (HSWA)
1ST

Round 2

Hunter Pollock HSWA		Hunter Pollock HSWA
Michael Stobinski Lake Erie	73	Fall 1:44

Drew LaPoint SWC3		Drew LaPoint SWC3
Nathan Thebeau Swanton	74	Fall 1:14

D. LaPoint (SWC3)
2ND

Round 3

Hunter Pollock HSWA		Hunter Pollock HSWA
Nathan Thebeau Swanton	133	Fall 0:42

Eli Guerra LEB1		Eli Guerra LEB1
Michael Stobinski Lake Erie	134	Dec 6-0

E. Guerra (LEB1)
3RD

Round 4

Hunter Pollock HSWA		Hunter Pollock HSWA
Eli Guerra LEB1	167	Fall 3:00

Drew LaPoint SWC3		Drew LaPoint SWC3
Michael Stobinski Lake Erie	168	TF 15-0

M. Stobinski (Lake Erie)
4TH

Round 5

Hunter Pollock HSWA		Hunter Pollock HSWA
Drew LaPoint SWC3	226	Maj 9-0

Eli Guerra LEB1		Eli Guerra LEB1
Nathan Thebeau Swanton	227	Fall 2:42

N. Thebeau (Swanton)
5TH

2018 Swanton Bill Urban Memorial

Division III 70-75

Round 1

Blake Brenner RMW2	Blake Brenner RMW2 Fall 1:30
Adyn Sheller EVEA	15

Gauge Sanchez GCWA	Dylan Kantner DTCWCA Dec 7-6
Dylan Kantner DTCWCA	16

I. Soto (Lake Erie)
1ST

Round 2

Isaac Soto Lake Erie	Isaac Soto Lake Erie SV-1 9-7
Dylan Kantner DTCWCA	75

Blake Brenner RMW2	Gauge Sanchez GCWA Dec 7-5
Gauge Sanchez GCWA	76

D. Kantner (DTCWCA)
2ND

Round 3

Isaac Soto Lake Erie	Isaac Soto Lake Erie Fall 0:36
Gauge Sanchez GCWA	135

Adyn Sheller EVEA	Dylan Kantner DTCWCA TF 16-1
Dylan Kantner DTCWCA	136

G. Sanchez (GCWA)
3RD

Round 4

Isaac Soto Lake Erie	Isaac Soto Lake Erie Fall 0:21
Adyn Sheller EVEA	169

Blake Brenner RMW2	Dylan Kantner DTCWCA Dec 9-2
Dylan Kantner DTCWCA	170

B. Brenner (RMW2)
4TH

Round 5

Isaac Soto Lake Erie	Isaac Soto Lake Erie Fall 1:39
Blake Brenner RMW2	228

Adyn Sheller EVEA	Gauge Sanchez GCWA Fall 1:34
Gauge Sanchez GCWA	229

A. Sheller (EVEA)
5TH

2018 Swanton Bill Urban Memorial

Division III 72-78

Round 1

Heath Norris HSWA	Heath Norris HSWA
Osiris Perez Lake Erie	TF 17-2
17	

Logan Craig GCWA	Max Beck AWC1
Max Beck AWC1	Dec 9-3
18	

H. Norris (HSWA)
1ST

Round 2

Chase Godwin SWC3	Chase Godwin SWC3
Max Beck AWC1	Dec 4-2
77	

Heath Norris HSWA	Heath Norris HSWA
Logan Craig GCWA	TF 15-0
78	

C. Godwin (SWC3)
2ND

Round 3

Chase Godwin SWC3	Chase Godwin SWC3
Logan Craig GCWA	Dec 6-0
137	

Osiris Perez Lake Erie	Max Beck AWC1
Max Beck AWC1	Dec 6-1
138	

M. Beck (AWC1)
3RD

Round 4

Chase Godwin SWC3	Chase Godwin SWC3
Osiris Perez Lake Erie	Dec 7-0
171	

Heath Norris HSWA	Heath Norris HSWA
Max Beck AWC1	Dec 2-0
172	

L. Craig (GCWA)
4TH

Round 5

Chase Godwin SWC3	Heath Norris HSWA
Heath Norris HSWA	Dec 5-0
230	

Osiris Perez Lake Erie	Logan Craig GCWA
Logan Craig GCWA	Fall 0:30
231	

O. Perez (Lake Erie)
5TH

2018 Swanton Bill Urban Memorial

Division III 78-85

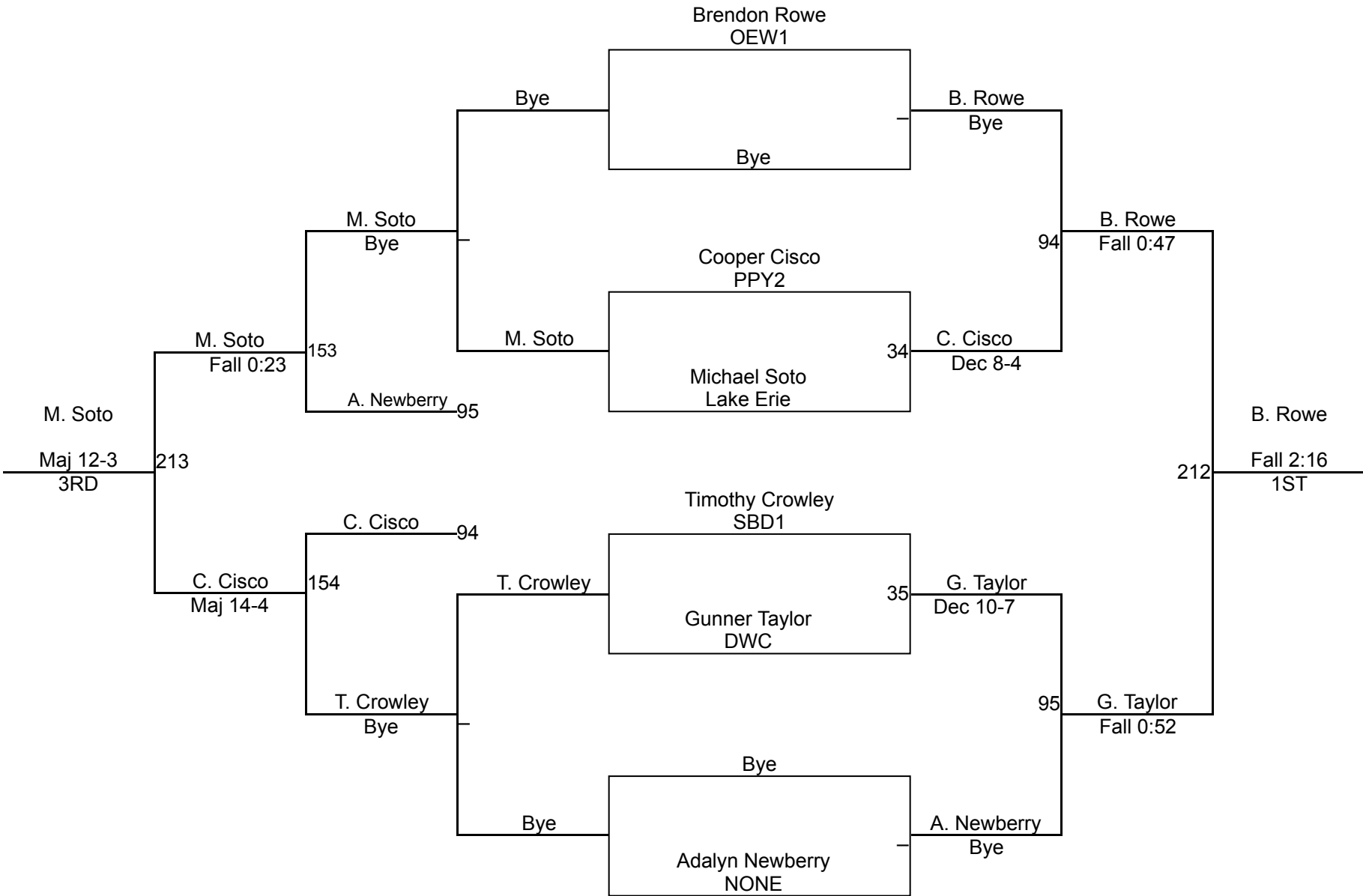

2018 Swanton Bill Urban Memorial

Division III 86-89

Round 1

Hudson Pancoast SWC3		Malakii Pinkelton Headstrong
Malakii Pinkelton Headstrong	19	Fall 0:52

Porter Kleeberg Beastmode		Porter Kleeberg Beastmode
Jakob Hoke GFF2	20	Fall 2:22

M. Pinkelton (Headstrong)
1ST

Round 2

Braden Bydlowski NONE		Braden Bydlowski NONE
Jakob Hoke GFF2	79	Maj 10-0

Hudson Pancoast SWC3		Porter Kleeberg Beastmode
Porter Kleeberg Beastmode	80	Fall 1:35

P. Kleeberg (Beastmode)
2ND

Round 3

Braden Bydlowski NONE		Porter Kleeberg Beastmode
Porter Kleeberg Beastmode	139	Dec 2-0

Malakii Pinkelton Headstrong		Malakii Pinkelton Headstrong
Jakob Hoke GFF2	140	TF 15-0

B. Bydlowski (NONE)
3RD

Round 4

Braden Bydlowski NONE		Malakii Pinkelton Headstrong
Malakii Pinkelton Headstrong	173	Fall 2:50

Hudson Pancoast SWC3		Jakob Hoke GFF2
Jakob Hoke GFF2	174	Fall 1:45

J. Hoke (GFF2)
4TH

Round 5

Braden Bydlowski NONE		Braden Bydlowski NONE
Hudson Pancoast SWC3	232	TF 15-0

Malakii Pinkelton Headstrong		Malakii Pinkelton Headstrong
Porter Kleeberg Beastmode	233	Dec 4-2

H. Pancoast (SWC3)
5TH

2018 Swanton Bill Urban Memorial

Division III 90-95

Round 1

Garrett Dziengelewski SWC3	Kaleb Martin PPY2	
Kaleb Martin PPY2	21	Fall 0:57

Conner Reese HWSA	Justin Crozier NONE	
Justin Crozier NONE	22	Dec 6-4

J. Crozier (NONE)
1ST

Round 2

Andrew Szczepanski LCW3	Justin Crozier NONE	
Justin Crozier NONE	81	Fall 1:35

Garrett Dziengelewski SWC3	Conner Reese HWSA	
Conner Reese HWSA	82	Fall 2:37

C. Reese (HWSA)
2ND

Round 3

Andrew Szczepanski LCW3	Conner Reese HWSA	
Conner Reese HWSA	141	Fall 0:57

Kaleb Martin PPY2	Justin Crozier NONE	
Justin Crozier NONE	142	Fall 1:21

K. Martin (PPY2)
3RD

Round 4

Andrew Szczepanski LCW3	Kaleb Martin PPY2	
Kaleb Martin PPY2	175	SV-1 7-5

Garrett Dziengelewski SWC3	Justin Crozier NONE	
Justin Crozier NONE	176	Fall 0:32

A. Szczepanski (LCW3)
4TH

Round 5

Andrew Szczepanski LCW3	Andrew Szczepanski LCW3	
Garrett Dziengelewski SWC3	234	Dec 10-5

Kaleb Martin PPY2	Conner Reese HWSA	
Conner Reese HWSA	235	Fall 1:28

G. Dziengelewski (SWC3)
5TH

2018 Swanton Bill Urban Memorial

Division III 96-106

Round 1

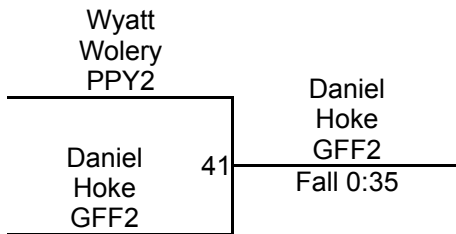
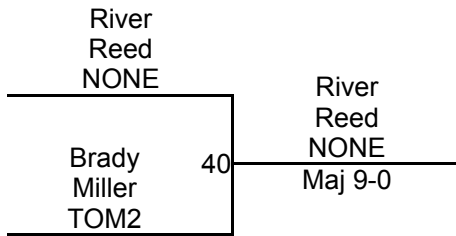

Round 2

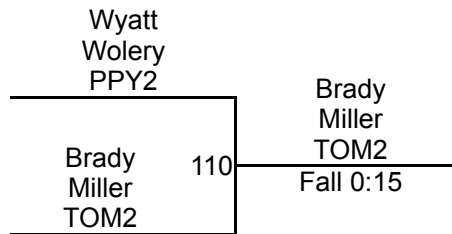
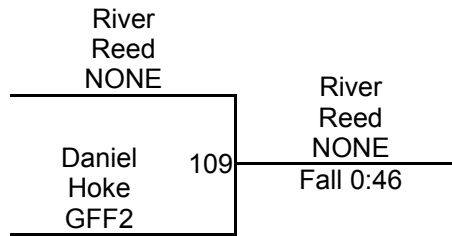

Round 3

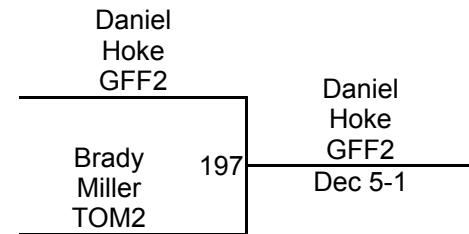
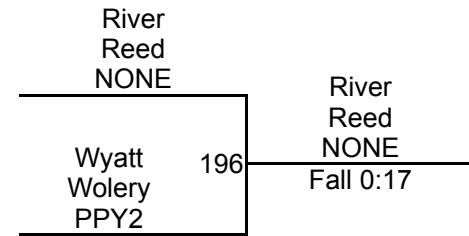

WRESTLERS

R. Reed (NONE)

B. Miller (TOM2)

W. Wolery (PPY2)

D. Hoke (GFF2)

R. Reed (NONE)

1ST

D. Hoke (GFF2)

2ND

B. Miller (TOM2)

3RD

W. Wolery (PPY2)

4TH

2018 Swanton Bill Urban Memorial

Division III 116-128

Round 1

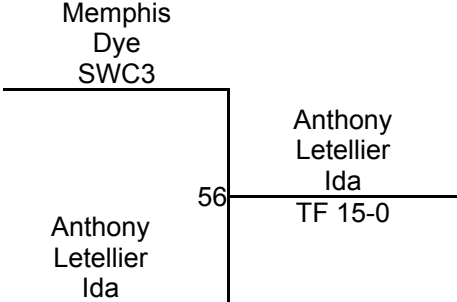

Round 2

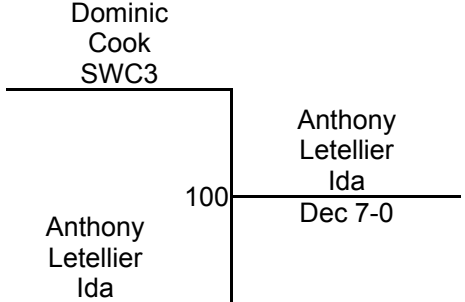

Round 3

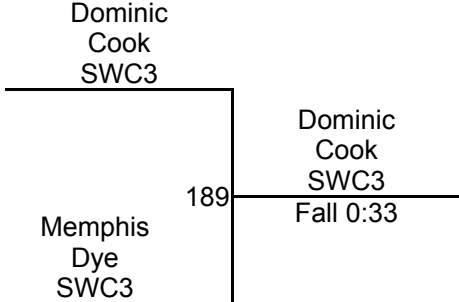

A. Letellier (Ida)
1ST

D. Cook (SWC3)
2ND

M. Dye (SWC3)
3RD

2018 Swanton Bill Urban Memorial

Division IV 63-67

Round 1

Eli Ogle PBG1		Corbin Kimmel DWC3	42	Corbin Kimmel DWC3	Fall 0:15
---------------------	--	--------------------------	----	--------------------------	-----------

Zavian LaFountain TOM2		Maxim Benore Bedford	43	Zavian LaFountain TOM2	Dec 7-2
------------------------------	--	----------------------------	----	------------------------------	---------

Round 2

Eli Ogle PBG1		Maxim Benore Bedford	111	Eli Ogle PBG1	Dec 4-0
---------------------	--	----------------------------	-----	---------------------	---------

Zavian LaFountain TOM2		Corbin Kimmel DWC3	112	Corbin Kimmel DWC3	Fall 2:46
------------------------------	--	--------------------------	-----	--------------------------	-----------

Round 3

Eli Ogle PBG1		Zavian LaFountain TOM2	198	Eli Ogle PBG1	Dec 6-2
---------------------	--	------------------------------	-----	---------------------	---------

Maxim Benore Bedford		Corbin Kimmel DWC3	199	Corbin Kimmel DWC3	Dec 7-2
----------------------------	--	--------------------------	-----	--------------------------	---------

WRESTLERS

E. Ogle (PBG1)

C. Kimmel (DWC3)

Z. LaFountain (TOM2)

M. Benore (Bedford)

C. Kimmel (DWC3)

1ST

E. Ogle (PBG1)

2ND

Z. LaFountain (TOM2)

3RD

M. Benore (Bedford)

4TH

2018 Swanton Bill Urban Memorial

Division IV 68-71

Round 1

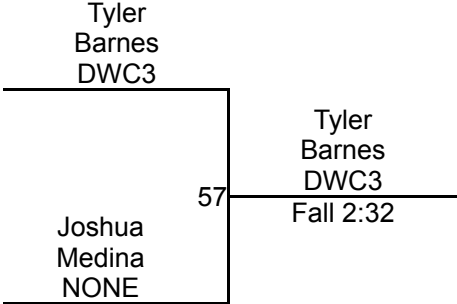

Round 2

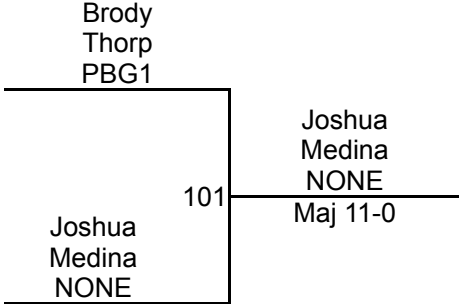

Round 3

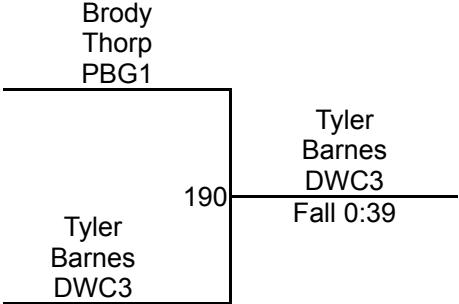

T. Barnes (DWC3)
1ST

J. Medina (NONE)
2ND

B. Thorp (PBG1)
3RD

2018 Swanton Bill Urban Memorial

Division IV 74-79

Round 1

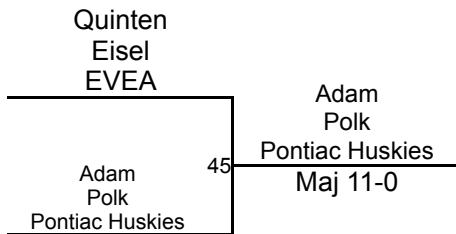
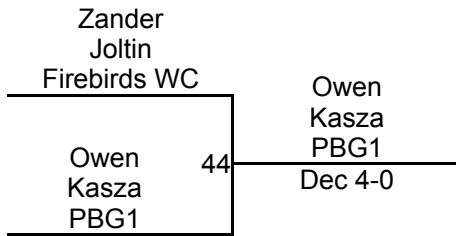

Round 2

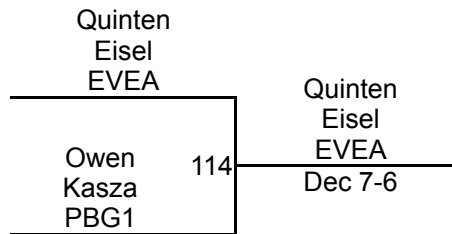
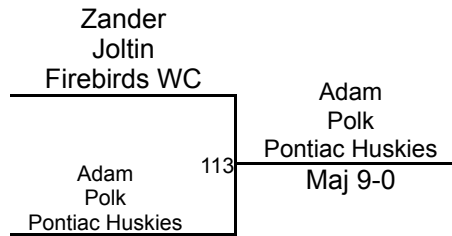

Round 3

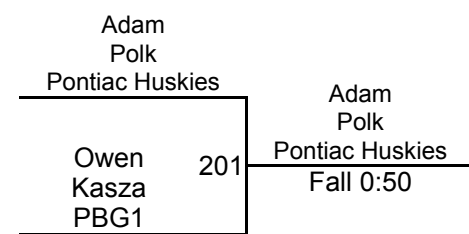
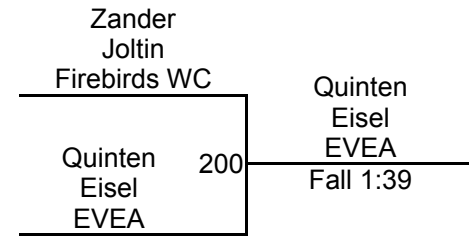

WRESTLERS

Z. Joltin (Firebirds WC)

O. Kasza (PBG1)

Q. Eisel (EVEA)

A. Polk (Pontiac Huskies)

A. Polk (Pontiac Huskies)

1ST

Q. Eisel (EVEA)

2ND

O. Kasza (PBG1)

3RD

Z. Joltin (Firebirds WC)

4TH

2018 Swanton Bill Urban Memorial

Division IV 80-84

Round 1

Noah Benore Bedford		Noah Benore Bedford
Richard Flores DWC3	46	TF 15-0

Gavin Shropshire ETOLA		Gavin Shropshire ETOLA
Colton Szczepanski LCW3	47	Fall 0:43

Round 2

Noah Benore Bedford		Noah Benore Bedford
Colton Szczepanski LCW3	115	Fall 0:32

Gavin Shropshire ETOLA		Gavin Shropshire ETOLA
Richard Flores DWC3	116	Dec 6-0

Round 3

Noah Benore Bedford		Noah Benore Bedford
Gavin Shropshire ETOLA	202	Dec 6-0

Colton Szczepanski LCW3		Richard Flores DWC3
Richard Flores DWC3	203	TF 15-0

WRESTLERS

N. Benore (Bedford)

R. Flores (DWC3)

G. Shropshire (ETOLA)

C. Szczepanski (LCW3)

N. Benore (Bedford)

1ST

G. Shropshire (ETOLA)

2ND

R. Flores (DWC3)

3RD

C. Szczepanski (LCW3)

4TH

2018 Swanton Bill Urban Memorial

Division IV 84-90

Round 1

Bryce Estep HSWA		Garrison Weisner KAWCA	
Garrison Weisner KAWCA	23	Dec 4-2	

Daniel Thatcher DWC3		Mazin Rukieh SWC3	
Mazin Rukieh SWC3	24	Dec 6-0	

G. Weisner (KAWCA)
1ST

Round 2

Braylon Miller TOM2		Braylon Miller TOM2	
Mazin Rukieh SWC3	83	Fall 0:52	

Bryce Estep HSWA		Bryce Estep HSWA	
Daniel Thatcher DWC3	84	Maj 12-2	

B. Estep (HSWA)
2ND

Round 3

Braylon Miller TOM2		Braylon Miller TOM2	
Daniel Thatcher DWC3	143	Fall 1:20	

Garrison Weisner KAWCA		Garrison Weisner KAWCA	
Mazin Rukieh SWC3	144	TF 19-4	

B. Miller (TOM2)
3RD

Round 4

Braylon Miller TOM2		Garrison Weisner KAWCA	
Garrison Weisner KAWCA	177	Dec 6-2	

Bryce Estep HSWA		Bryce Estep HSWA	
Mazin Rukieh SWC3	178	Fall 0:49	

M. Rukieh (SWC3)
4TH

Round 5

Braylon Miller TOM2		Bryce Estep HSWA	
Bryce Estep HSWA	236	Maj 8-0	

Garrison Weisner KAWCA		Garrison Weisner KAWCA	
Daniel Thatcher DWC3	237	TF 17-2	

D. Thatcher (DWC3)
5TH

2018 Swanton Bill Urban Memorial

Division IV 91-99

Round 1

Braxden Martin PPY2	Vincent Maurer DWC	25	Dec 5-0
Vincent Maurer DWC			

Lane Konrad SWC3	Juan Hernandez TX	26	Fall 0:28
Juan Hernandez TX			

J. Hernandez (TX)
1ST

Round 2

Gage Wilcox Hornet WC	Juan Hernandez TX	85	TF 16-1
Juan Hernandez TX			

Braxden Martin PPY2	Braxden Martin PPY2	86	Fall 1:35
Lane Konrad SWC3			

V. Maurer (DWC)
2ND

Round 3

Gage Wilcox Hornet WC	Lane Konrad SWC3	145	Fall 2:00
Lane Konrad SWC3			

Vincent Maurer DWC	Juan Hernandez TX	146	Fall 0:36
Juan Hernandez TX			

B. Martin (PPY2)
3RD

Round 4

Gage Wilcox Hornet WC	Vincent Maurer DWC	179	Fall 0:53
Vincent Maurer DWC			

Braxden Martin PPY2	Juan Hernandez TX	180	Fall 1:48
Juan Hernandez TX			

L. Konrad (SWC3)
4TH

Round 5

Gage Wilcox Hornet WC	Braxden Martin PPY2	238	Fall 1:50
Braxden Martin PPY2			

Vincent Maurer DWC	Vincent Maurer DWC	239	Fall 0:25
Lane Konrad SWC3			

G. Wilcox (Hornet WC)
5TH

2018 Swanton Bill Urban Memorial

Division IV 101-110

Round 1

Scott Speakman WKS1		Scott Speakman WKS1	
Trent Johnson PHW3	27	TF 15-0	

Antonio Salazar HWSA		Antonio Salazar HWSA	
James Borck DWC	28	Fall 0:25	

A. Salazar (HWSA)
1ST

Round 2

Evan Reed SWC3		James Borck DWC	
James Borck DWC	87	Fall 2:36	

Scott Speakman WKS1		Antonio Salazar HWSA	
Antonio Salazar HWSA	88	Dec 4-2	

S. Speakman (WKS1)
2ND

Round 3

Evan Reed SWC3		Antonio Salazar HWSA	
Antonio Salazar HWSA	147	Fall 2:23	

Trent Johnson PHW3		Trent Johnson PHW3	
James Borck DWC	148	Fall 0:36	

T. Johnson (PHW3)
3RD

Round 4

Evan Reed SWC3		Trent Johnson PHW3	
Trent Johnson PHW3	181	Dec 4-3	

Scott Speakman WKS1		Scott Speakman WKS1	
James Borck DWC	182	TF 17-2	

J. Borck (DWC)
4TH

Round 5

Evan Reed SWC3		Scott Speakman WKS1	
Scott Speakman WKS1	240	Fall 1:31	

Trent Johnson PHW3		Antonio Salazar HWSA	
Antonio Salazar HWSA	241	Fall 0:24	

E. Reed (SWC3)
5TH

2018 Swanton Bill Urban Memorial

Division IV 111-124

Round 1

Jaiden Sarabia NONE		Jaiden Sarabia NONE
Braden Anderson LAW3	48	Fall 2:20

Blake Denman Hornet WC		Kaiden Bryan SWC3
Kaiden Bryan SWC3	49	Dec 7-0

Round 2

Jaiden Sarabia NONE		Jaiden Sarabia NONE
Kaiden Bryan SWC3	117	Dec 3-0

Blake Denman Hornet WC		Blake Denman Hornet WC
Braden Anderson LAW3	118	Maj 11-0

Round 3

Jaiden Sarabia NONE		Jaiden Sarabia NONE
Blake Denman Hornet WC	204	Fall 1:43

Kaiden Bryan SWC3		Kaiden Bryan SWC3
Braden Anderson LAW3	205	Fall 0:27

WRESTLERS

J. Sarabia (NONE)

B. Anderson (LAW3)

B. Denman (Hornet WC)

K. Bryan (SWC3)

J. Sarabia (NONE)

1ST

K. Bryan (SWC3)

2ND

B. Denman (Hornet WC)

3RD

B. Anderson (LAW3)

4TH

2018 Swanton Bill Urban Memorial

Division IV 133-133

Round 1

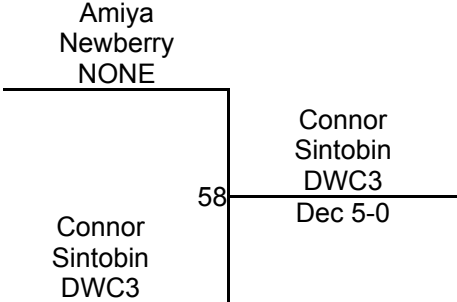

Round 2

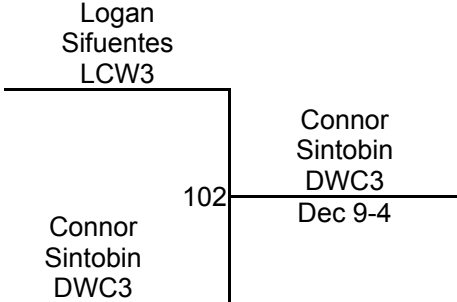

Round 3

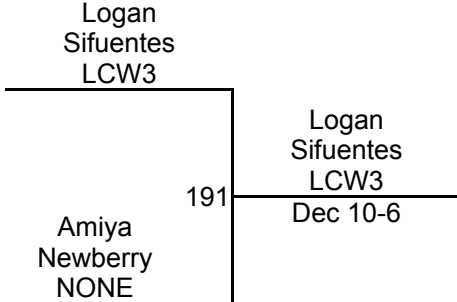

C. Sintobin (DWC3)
1ST

L. Sifuentes (LCW3)
2ND

A. Newberry (NONE)
3RD

2018 Swanton Bill Urban Memorial

Division IV 144-178

Round 1

Zaydin Morrison EWOA		Evan Smigelski SWC3
Evan Smigelski SWC3	50	Dec 4-0

Donovan Gayle TLWA		Donovan Gayle TLWA
Caleb Bowman GCWA	51	Dec 5-3

Round 2

Zaydin Morrison EWOA		Caleb Bowman GCWA
Caleb Bowman GCWA	119	Fall 1:42

Donovan Gayle TLWA		Donovan Gayle TLWA
Evan Smigelski SWC3	120	Dec 3-0

Round 3

Zaydin Morrison EWOA		Donovan Gayle TLWA
Donovan Gayle TLWA	206	Fall 0:37

Caleb Bowman GCWA		Evan Smigelski SWC3
Evan Smigelski SWC3	207	Dec 3-2

WRESTLERS

Z. Morrison (EWOA)

E. Smigelski (SWC3)

D. Gayle (TLWA)

C. Bowman (GCWA)

D. Gayle (TLWA)

1ST

E. Smigelski (SWC3)

2ND

C. Bowman (GCWA)

3RD

Z. Morrison (EWOA)

4TH